

STEPS

(1) Hardware



(2) Fabric banner



(3) TV mount x1 / Brochure rack x2
Tablet PC holder x1

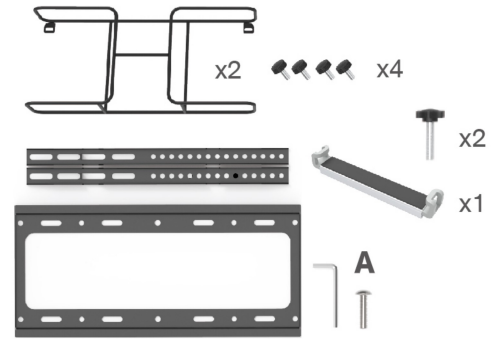

STEP 01

To connect the poles according to the labellings

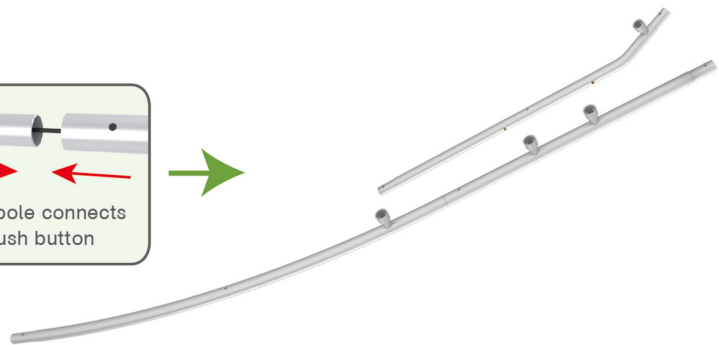
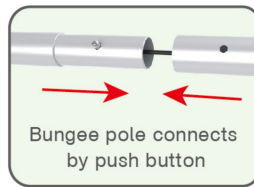
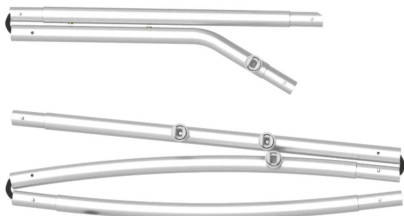

STEP 02

To use corner pieces to connect the poles to be display stand

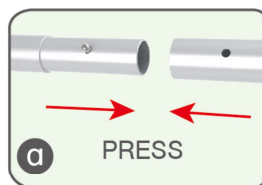
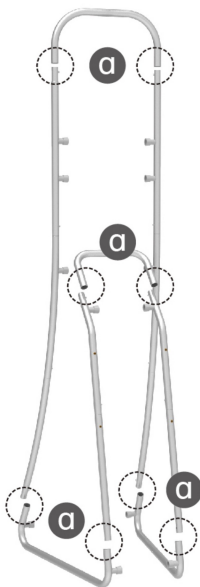

STEPS

STEP 03

To install the cross bar according to labellings

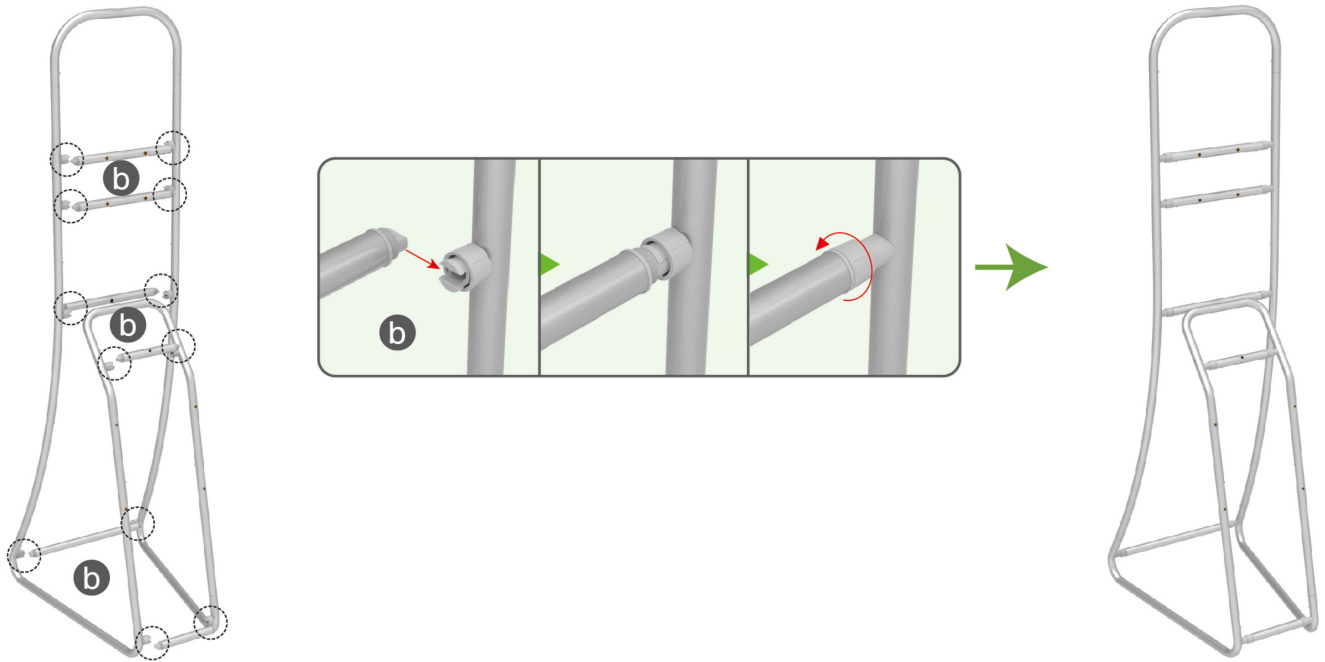

STEP 04

To wrap the fabric from ipad end to the top where the TV located and zip up, afterwards use big screw for fastening the whole unit

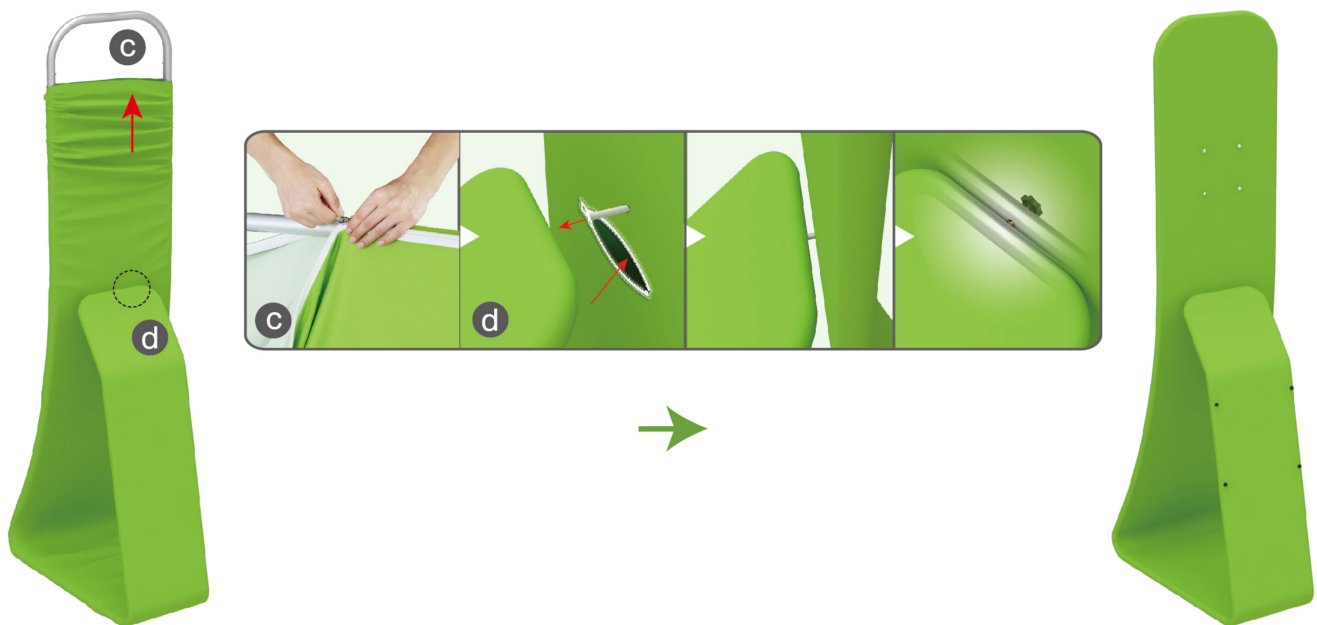

STEPS

STEP 05

To install TV rack

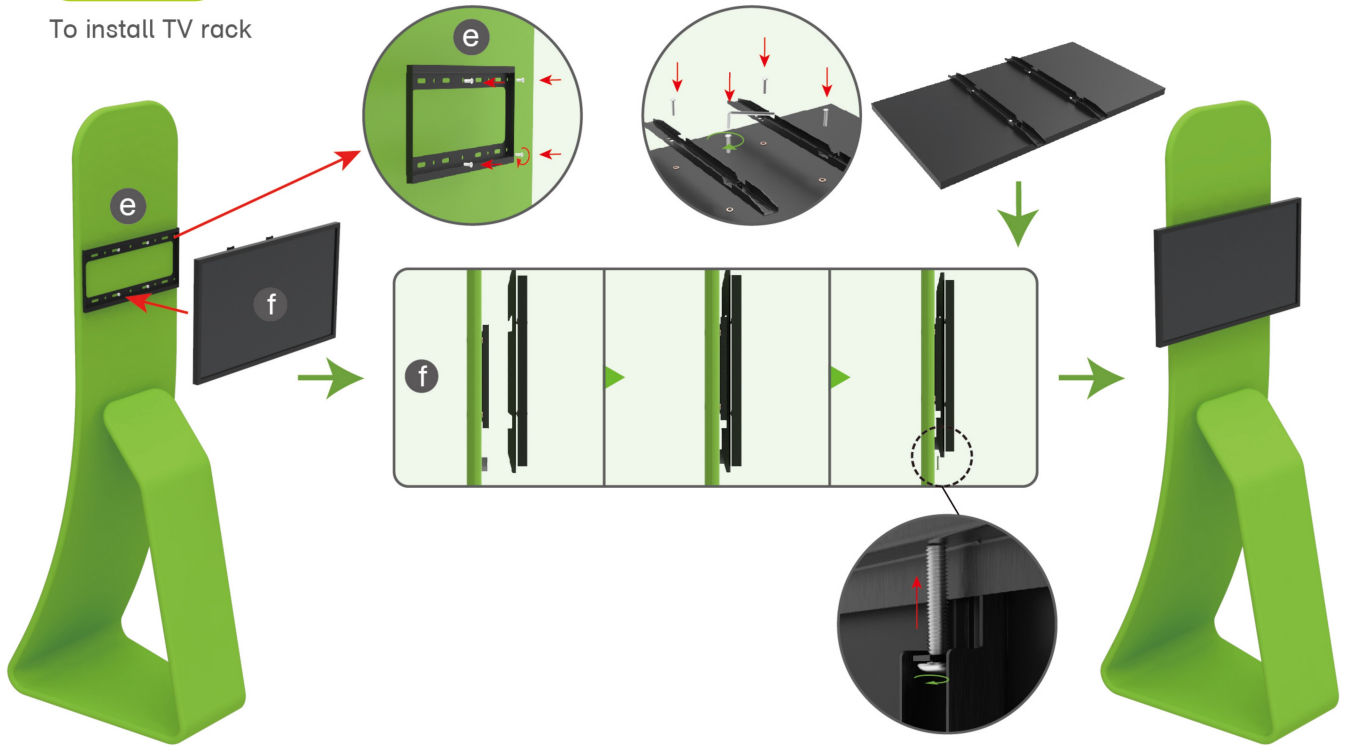

STEP 06

To adjust the holder size and put the tablet PC in position then use Allen Key for fastening, afterwards whole kit install onto the stand by using screw.

The holder is suitable for mini iPad to 14" of Tablet PC

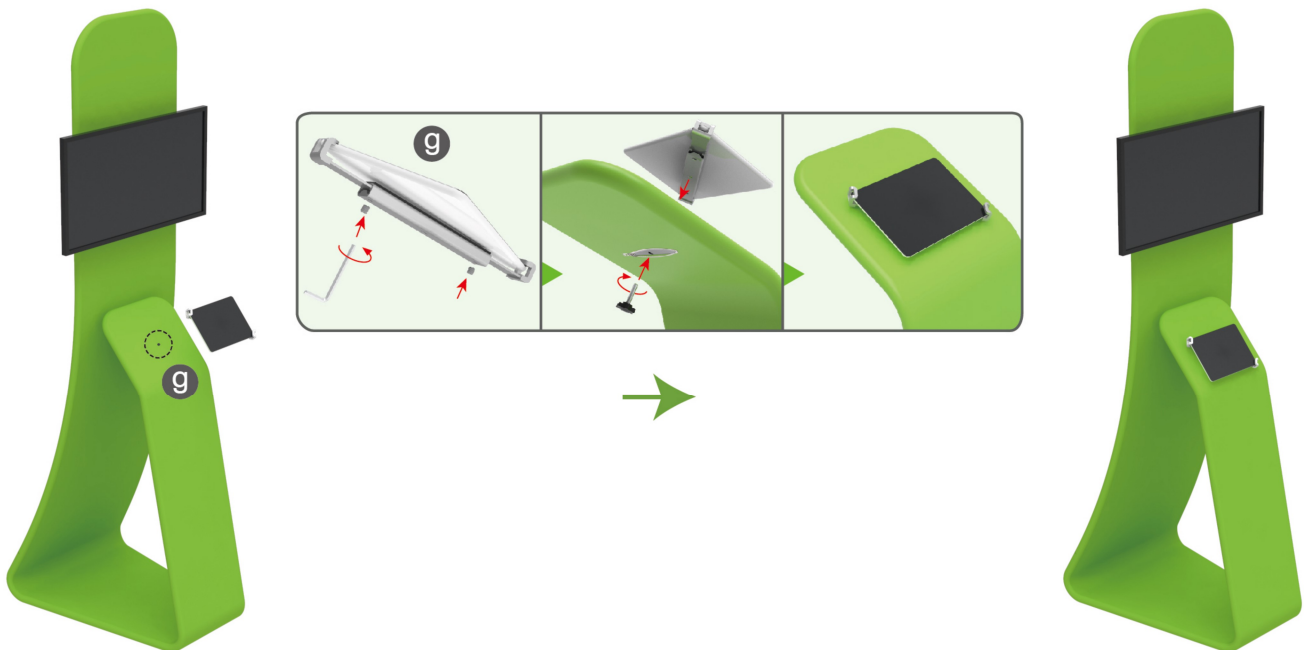

STEPS

STEP 07

To install 2 racks by screws in position

